



eGauge Model EG4xxx Owner's Manual Version 2.0

eGauge Systems LLC
1644 Conestoga St, Suite 2
Boulder, CO 80301
<http://egauge.net/>
877.EGAUGE1
720.545.9767

March 19, 2024

Download the latest manual at egauge.net/support/manual
For an overview of setup process, visit egauge.net/start

1 Introduction

Thank you and congratulations on your purchase of an eGauge device! Properly installed, the device will be able to record and report energy usage and production for years to come.

The first and second section of this manual describes installation and commissioning of the product. The third section provides operating instructions and is followed by a section on equipment maintenance. The appendices provide the device specifications and a reference to troubleshooting information.

Please visit the eGauge support site to verify you have the latest version of this manual. There, you can also find additional training materials, tutorial videos, configuration guide, and CT-selection guides:

<http://kb.egauge.net/>

2 Installation

Installation must be performed by a licensed electrician according to all applicable local, national, and international codes.

CAUTION: The eGauge power connector carries high voltage. For safety, the device must be installed in a suitably rated enclosure for the installation environment. The enclosure must have a screw-on or locking cover that prevents accidental touch of the power connector.

2.1 What's included in the box

- 1× EG4xxx device
- 1× AC Power plug (5-position plug)
- 1× DC Power plug (2-position plug)
- 0–30× Current transformers (CTs) w/ 8ft wires & plug (as ordered)
- 1× WiFi antenna (if using EG42xx)

2.2 Materials required for installation

- Per phase: Use of proper smallest available breakers or rated fuse taps (**max 15A**) for the install per local NEC rules. Usually 15A circuit breaker or single multi-pole breaker depending on phases used.
- Black, red, and white stranded AWG 12 wire; length depending on installation location. Thermal resistance to at least 75°C. Blue wire is needed in addition for 3-phase installations. Use wire that has insulation rating greater than the max voltage inside the panel. *Note: wire colors may vary based on country and electrical service.*
- Electrical tape
- Conduit and couplings as needed
- Mounting and wire organization hardware as needed
- If installed outside, appropriately rated enclosure (e.g. IPX4/NEMA4)

2.3 Tools required for installation

- #0 slotted screw driver (needed if length of CT-wires needs to be adjusted)
- Voltage meter

Additionally, for device commissioning and installation verification:

- Clamp-on AC current meter
- Laptop (an Ethernet port is required if there is no local network and the meter is not WiFi-enabled).

2.4 Nomenclature and Symbols

In the US, residences typically receive power through split-phase power distribution which is provided through two hot legs, a neutral, and a protective ground.

Most commercial and industrial buildings receive power through 3-phase power distribution provided through 3 hot phases, a neutral and protective ground.

Throughout the rest of this document, we use the term “phase” to refer both to the phases of 3-phase power distribution as well as the two legs used in split-phase power distribution.

The following table describes the symbols used on the device:

Symbol:	Description:
	Caution, risk of danger.

2.4.1 Measurement Category

Measurement Category III is for measurements performed in the building installation. Examples are measurements on distribution boards, circuit-breakers, wiring, including cables, bus-bars, junction boxes, switches, socket-outlets in the fixed installation, and equipment for industrial use and some other equipment, for example, stationary motors with permanent connection to the fixed installation.

2.5 Safety Warnings

Please follow the installation instructions in this manual for wiring diagram and proper selection of CTs.

To reduce the risk of electric shock:

- Do not connect device to a circuit operating at > 277 Vrms to neutral.
- Always connect an appropriate neutral connection (not ground), and do not apply voltage to device without an appropriate N terminal connection.
- Always open or disconnect circuits from Power Distribution System of building before installing or servicing the unit or attached current transformers.
- Only connect authorized 0.333Vrms CTs to the CT inputs of the device (see section B.6).

2.6 Installation Location

The eGauge is usually installed near the power-distribution panel of a building, where there is easy access to the power circuits to be measured.

The eGauge is permanently connected equipment. A 15A circuit-breaker shall be included (one per phase) in close proximity of the device and within easy reach of the operator. The breakers shall be marked as the disconnecting device for eGauge. The breakers shall be wired to the device in compliance with the NFPA 8 National Electrical Code using a conductor size of at least AWG12 and tightened to 10 ft-lb.

The eGauge is a listed device and must be installed inside a suitable enclosure. The enclosure eGauge is installed in must be rated according to the environment it is used in. For example, outdoor installations require an outdoor-rated enclosure (e.g., IPX4/NEMA4).

Select an installation location that is not exposed to direct sunlight or the elements. Otherwise, the warranty may be voided.

Do not install the device in a way that would make it difficult to operate the disconnecting device (circuit breakers).

2.7 Device Overview

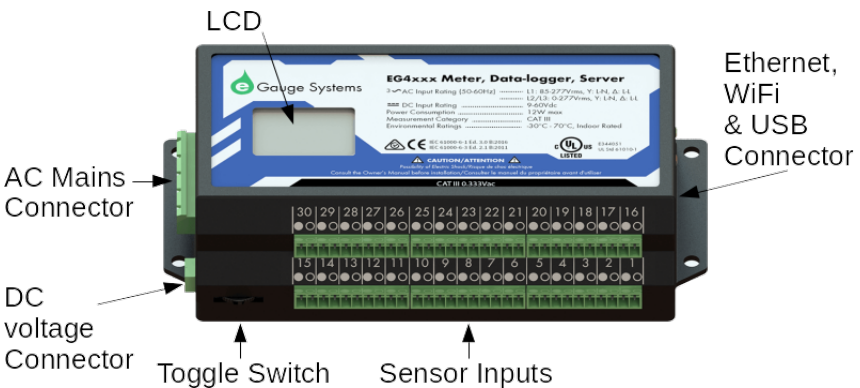

Figure 1: eGauge inputs and outputs

As shown in Figure 1, the eGauge has three input connectors: the **AC Mains** is a 5-pin connector used to wire the device to the building supply. The **DC Connector** is a 2-pin connector for monitoring or powering from a DC voltage. The **CT Connector** is used to connect current transformers (CTs) or other sensors. The LCD and multi-switch provide some user interface.

The unit also has an Ethernet port (RJ45 connector) which can be used to hard-wire the device to a Local Area Network (LAN). It also has two USB ports (Type-A Female) to interface to various other IT devices.

An LCD shows a basic user interface with readouts from the set variable registers. It may be controlled through the multi-switch for basic control and configuration.

2.7.1 LCD

The **LCD** is an installation aid shown in Figure 2. When powered on, the LCD will show a eGauge logo as the device boots. During this time the backlight will flicker showing boot activity. Once the LCD shows the first register screen, the device is automatically recording data if configured to do so.



Figure 2: eGauge LCD

Visit <http://egauge.net/support/lcd> for full information on using the LCD.

2.7.2 AC Mains Connector

This connector is shown in Figure 3 and the pin-out is as follows:

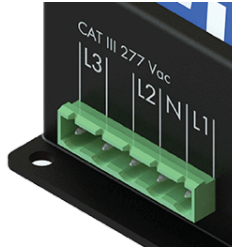

Figure 3: AC Mains Connector

Pin:	Name:	Description:
1	L1	Wire to phase 1 of building supply.
2	N	Wire to building's Neutral.
3	L2	Wire to phase 2 of building supply for split- and three-phase installs.
4		Unused. Leave unconnected.
5	L3	Wire to phase 3 of building supply for three-phase installs.

The AC Mains Connector is CAT III rated (for measurements performed in the building installation, such as circuit breakers). Pin L1 serves three purposes: it powers the device (2W typical, 12W maximum), the voltage on the line is measured to calculate power used/generated on phase L1, and it carries the power-line signal for communicating with the HomePlug AV wall-plug adapter. The pin must be wired to the building's power supply with a voltage in the range from 85–277Vrms (to neutral). In contrast, pins L2 and L3 are used purely as voltage-taps so power used/generated on phases L2 and L3 can be calculated. Wiring these pins is necessary only if there are CTs measuring current(s) on L2/L3. The voltage on these lines can be 0–277Vrms (Vac or Vdc).

To measure any signal on the AC Mains Connector L1 and N must be powered with at least 85Vrms. If no voltage is supplied to this port, then the unit will not measure any signal from L1, L2, or L3. The unit can continue to operate if powered by the DC port.

Warning: The eGauge requires an appropriate N terminal connection (see configuration guide wiring diagrams for examples). If AC voltage is applied without an appropriate N connection, damage to the unit may occur.

2.7.3 DC Connector

This connector is shown in Figure 4 and the pin-out is as follows:



Figure 4: DC Connector

Pin:	Name:	Description:
1	+	Wire to DC signal.
2	-	Wire to ground.

The DC Connector CAT III rated for use from -60 – 60Vdc. It can measure the voltage across that full range but if powered by the DC port, there must be at least 9Vdc. If an installation utilizes both the AC Mains Connector as well as DC Connector, and DC power is used to power the unit, there must be more than 12Vdc to ensure unit pulls power from the DC port.

2.7.4 CT Connector

This connector is shown in Figure 5. It provides 15 or 30 positions for the CT plugs illustrated in Figure 9. The silk-screened numbers indicate which CT should be connected to which pair of pins. Pins that are to receive the black wire of the CTs are marked with a circle with black interior, pins for the white wires are marked with a circle with white interior.

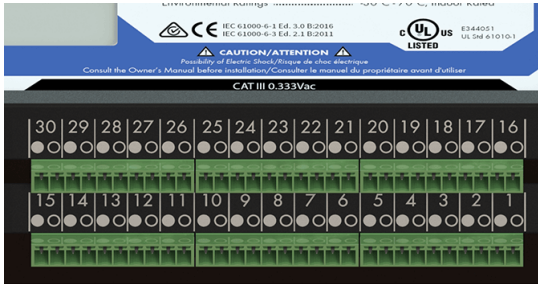

Figure 5: CT Connector

The CT Connector is rated for wiring one to thirty units of the CTs listed in Section B.6. The input voltage rating is $0.333V_{rms}$ at the rated current.

NOTE: There is no risk of damage if a CT plug is accidentally inserted such that it straddles the pins for two different CTs. If this happens, the eGauge will not be able to measure power properly but otherwise there are no ill effects. To correct the problem, simply remove and re-insert the plug at the right position.

2.7.5 Ethernet (LAN), USB and WiFi Connector

This connector is shown in Figure 6. It provides hard-wired Ethernet connectivity via an RJ45 plug, two USB host ports via Type-A Female plugs, and on EG42xx models an RP-SMA antenna connector for WiFi connectivity.

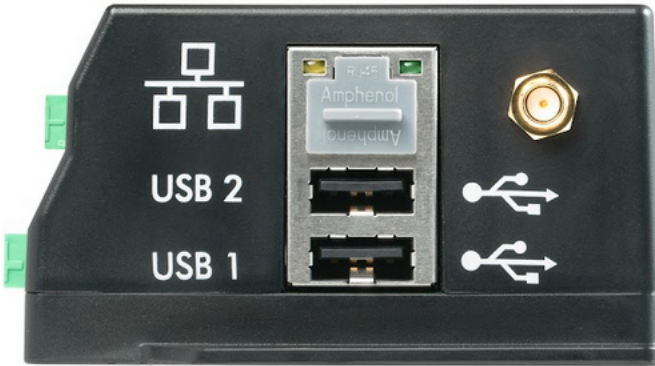

Figure 6: Ethernet Connector

Meters are shipped with a dust cover in the Ethernet port. This should not be removed unless an Ethernet connection is used.

The LED in the top-left corner of the connector turns on when an Ethernet cable is plugged in and a valid Ethernet carrier signal has been detected. The LED goes dark briefly whenever data is being exchanged over the cable. The LED in the top-right corner of the connectors is a speed indicator. It turns on when operating at 100Mbps and is off (dark) when operating at 10Mbps.

The USB ports are USB2.0 compatible and can supply up to 1A at 5V. They may be used with various components made by eGauge Systems such as USB-RS485 serial converters, power relay modules, and other equipment.

2.7.6 Multi-switch

Figure 7 is a close-up of the multi-switch. The user can slide the switch Left or Right for navigation and push the switch into the unit to select.



Figure 7: Multi-Switch

The multi-switch can be used to navigate the LCD menu system. By default, any action seen from the multi-switch will wake the backlight to ensure a viewable interface.

2.7.7 Time Reference

During normal operation, the eGauge maintains accurate time by synchronizing with an NTP server, such as one of the public servers available at ntp.org. Since NTP provides atomic-clock accuracy, there is usually no need to set the time manually.

When the NTP server is not accessible, either temporarily (e.g., after a power failure) or permanently (e.g., at a remote site), the eGauge relies on a Super Capacitor backed real-time clock to maintain proper time.

The backup is designed only to cover relatively short power outages. The Super Capacitor takes about 5 minutes to fully charge, and will keep correct time for approximately 8 hours without power.

When power is restored after such an event, the eGauge will attempt to restore proper time via the NTP server. If unavailable, and the Super Capacitor is depleted, the device will fall back to using the time that was in effect when the last data item was recorded prior to the power failure. The proper time must then be restored later on, either manually via the device's **Settings**→**Date & Time** page or by provisioning an NTP server that is accessible.

2.8 Wiring Diagram

2.8.1 Typical Residential (Split-Phase) Installation

Figure 8 is a schematic wiring diagram showing a typical split-phase installation where the eGauge is used to measure the amount of power being supplied by the power utility (CTs 1–2) and the power supplied by a single-phase solar inverter (CT 3). For simplicity, circuit-breakers are not shown.

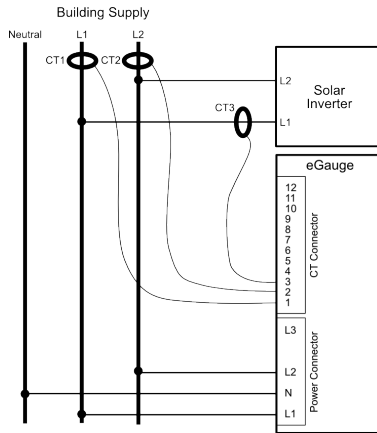

Figure 8: Wiring Diagram for a Typical Split-Phase Installation

2.8.2 Other Installations

For commercial three-phase installation as well as many other installation and configuration-scenarios, please refer to the Configuration Guide, available at:

<http://kb.egauge.net/>

2.9 Installation steps

1. Install the new breaker(s) in the power-distribution panel such that they provide access to all phases.
2. Open the breakers so there is no power on the breaker contacts.
3. Mount the eGauge inside a suitable enclosure near the power distribution panel.
4. Wire the 5-position plug as follows:
 - (a) Black wire: pin labeled L1 to breaker for phase L1.
 - (b) White wire: pin labeled N to Neutral.
 - (c) Red wire: pin labeled L2 to breaker for phase L2.
 - (d) Blue wire: pin labeled L3 to breaker for phase L3 (3-phase installations only).

Note: Colors may vary based on country and electrical service type. For other types of systems, including deltas without a neutral, visit the knowledgebase at <http://kb.egauge.net> to view the configuration guide and alternative system wiring diagrams.

5. Verify with a volt-meter that the breaker's phase connected to the meter L1 is the phase same as the service L1, and again for L2 and L3. Visit <http://egauge.net/support/phasing> for more information.
6. Open the CT head and place it around the conductor to be measured. **Do not not touch the polished ferrite core surface on split-core CTs.** Close the CT head and ensure it is fully shut by squeezing the ends together. J&D CTs require two clicks to fully shut.

For additional information about a particular model CT, please visit <http://egauge.net/support/cts>

NOTE: Ensure the CTs are facing the correct direction

- J&D CTs: Point the sticker towards what is being measured.
- Orange Rope CTs: Point the arrow towards what is being measured.
- eGauge ECS20 CTs: Current should flow in the same direction the arrow points.

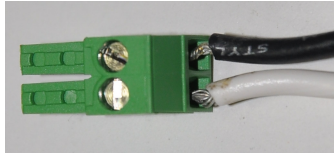

Figure 9: Correct wiring for 2-pin CT plug

7. Insert the 2-pin CT plugs into the Sensor Port on the eGauge and record the amperage of the CT, the phase being measured, and the item being measured in the table in Appendix D.

If it is necessary to shorten or lengthen the CT wires, ensure that the CT wires are connected as shown in Figure 9.

8. Close the newly installed breakers. This should cause the eGauge to power up and, within a few seconds, the LCD will illuminate and show an eGauge logo. Once the screen changes to the first register readout, the measurements have started. The user can use the LCD to verify a network connection. At that point, it can be found at <http://egauge.net/devices/>. For this to work, the device needs to be able to make an **outgoing TCP connection to port 8084** of host `d.egauge.net`.
9. Label the newly installed breakers as “eGauge Disconnect” so the customer can readily find them if it becomes necessary to power-cycle or turn off the eGauge device for any reason.

IMPORTANT: Labeling the breaker(s) is essential. Do not skip that step. Occasionally, it may be necessary to power-cycle the device. The breaker(s) provide the only safe way to do that, so for safety-reasons, it is important that the end-customer is able to identify the eGauge breaker(s) without having to open any enclosures.

3 Commissioning

After installation, it is essential to verify that the device is operating properly and measuring the expected quantities. Each device ships with a default configuration that may or may not match your installation situation. In general, it is therefore necessary to adjust the settings to match your situation. Please see the Configuration Guide for details (available at <http://kb.egauge.net/>).

For revenue-grade accuracy compliance, the eGauge must be paired with revenue-grade CTs tested and supported by eGauge. Please contact eGauge Systems for details.

Use a laptop or another computer to connect to the device's built-in web-server (see next section). Then, as described in the Configuration Guide, **Tools**→**Channel Checker** can be used to confirm that:

1. All voltages have the expected values (use voltage meter to verify).
2. All CTs report the expected currents (use clamp-on current meter to verify).
3. CTs are indeed installed on the phases set under **Settings**→**Installation**. The voltage between the wire that the CT is clamped onto and the power-plug pin (L1-L3) that corresponds to the phase it is configured for should be zero Volts.
4. All reported power values have expected polarity and power-factors. As a general rule, eGauge convention requires that power coming into the site shows as positive values and power being consumed at or diverted from the site shows as negative values.

Also confirm that the eGauge dash-board shows a red line for total consumption. Assuming all power coming into a site is measured by the device, this line should never dip into the negative. As a final check, it is helpful to turn on and off some large loads to confirm everything operates as expected. If there is a renewable energy system on site, turning it on/off should not appreciably affect the red line (total consumption).

4 Operation

4.1 Accessing your eGauge for the first time

Once the eGauge is installed, you can access it from any computer on your Local Area Network (LAN) with an up-to-date modern browser such as Chrome, Firefox, Safari, Edge or Brave. You may also use the eGauge App on an up-to-date Android or Apple phone or tablet. The app may be found in the Google Play and Apple store.

An example of the eGauge Chart can be seen in Figure 10. Older meters may display the older "Classic" interface by default, even on newer firmware. For more information, visit <http://egauge.net/support/modern>.

To start, enter the following Web address into your web-browser:

Microsoft Windows: <http://devname/>
All other computers: <http://devname.local/>

where *devname* is the name of the device (e.g., eGauge9999). For example, to access device eGauge9999, you would enter the following URL into your browser:

Microsoft Windows: <http://egauge9999/>
All other computers: <http://egauge9999.local/>

You may also use the LCD display to find the local IP address of the eGauge on the network. Use the multi-switch on the main register display to scroll to the last page containing the hostname and IP address of the eGauge. It will also periodically display as the register screen changes. Visit the IP address in a web-browser, for example, <http://192.168.2.120/>.

4.2 Accessing your eGauge from the Internet

To access the eGauge from the Internet, open a compatible web-browser and then visit the Web page at: <http://egauge.net/devices/>.

Type the name of your device into the search box on that page (or any unique part of it) and then click on the the matching entry.

Alternatively, you can directly enter the following web address into your browser: `http://devname.egaug.es/` where *devname* is the name of your device (e.g., “eGauge9999”).

You can also use the above URL as an alternative means to connect to your device directly through your LAN. To accomplish that, click on the **LAN Access** link on the top right of the page, once the device's dashboard has loaded. This directs your browser to access the device directly (through your LAN rather than going through `egaug.net`). This is both faster and allows you to access the device even at times when your Internet-connection may not be working properly. Please bookmark the address displayed in the browser after the page referred to by the **LAN Access** link has finished loading.

Tutorials for using the chart and dashboard interface are available at `http://kb.egaug.net/`.

NOTE: From time to time, the local IP address of your eGauge may change and the bookmark will stop working. Should this happen, repeat the above steps and update the bookmark with the new address. Usually, this happens infrequently, if at all. However, since it *can* happen, we recommend using the connection-methods described in the previous section whenever possible. Alternatively, a static (fixed) address can be configured for the device. See the next section for details.

The eGauge proxy service is best-effort and not guaranteed to be available at all times. See the Proxy Server Statement on <http://www.egaug.net/policy/> for more details.

4.3 Configuring a Static IP Address

The eGauge normally automatically obtains its IP address and associated information through a service called Dynamic Host Configuration Protocol (DHCP). If you cannot or do not wish to run this service on your LAN, the device will default to using IP address 192.168.1.88, so the device can be accessed as:

`http://192.168.1.88/`

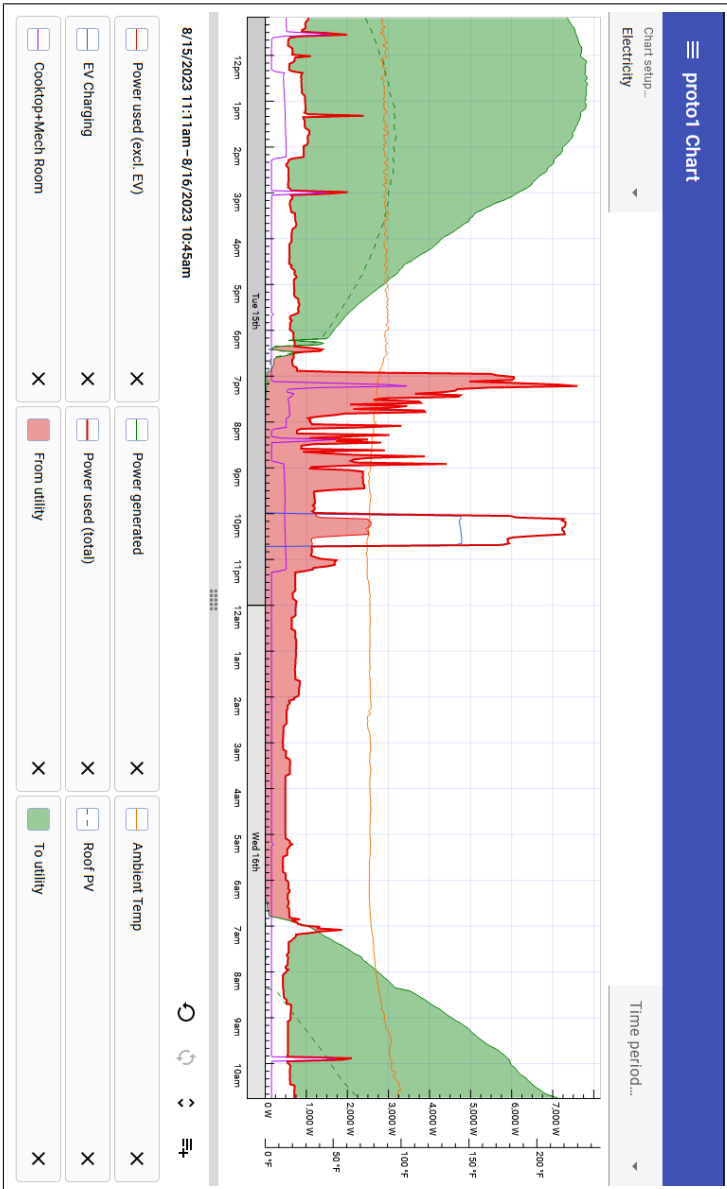

Figure 10: Modern Interface chart view.

Your computer's IP address must be configured to be on the same range as this default address. If another device ends up using the same address, or a static IP address is required, you may configure one from **Settings**→**Network Settings**. Please visit <http://egauge.net/support/static-ip> or <http://kb.egauge.net> for additional documentation on connecting directly to an eGauge and assigning a static IP address.

4.4 Verifying the Proper Time

When the Internet is not available to the eGauge, it may be necessary to set the date and time manually. To verify that the eGauge has the proper time, use a browser to go to the device's dashboard (see previous sections), then click on **Settings**, then on **Date & Time**. If the displayed date and/or time is wrong, please enter the correct values and then click on **Save**. Please repeat this step from time to time, especially after prolonged power outages lasting more than a few hours.

4.5 Passwords and Saving Settings

By default, changes may be made using user-name **owner**. Prior to January 2021, the password is **default**. Meters are now shipped with a random **owner** password which is printed on a label on the side opposite CT inputs, next to the label with the serial number and MACs. You must connect to the eGauge directly over the local network before making changes. This can be accomplished by clicking the **LAN Access** link in the upper-right hand menu on the eGauge main interface. Credentials and remote administration can be managed in **Settings**→**Access Control**. Custom ordered meters may not have standard default credentials configured.

5 Maintenance

The eGauge is designed to be maintenance free. No preventive maintenance or inspections are required.

Should it become necessary to clean the eGauge, disconnect it from the building supply by turning off the breakers labeled "eGauge Disconnect", remove the device, and clean it with a soft cloth. If a cleaning fluid is needed, use 70%

isopropyl alcohol. Wait until all cleaning fluid has evaporated before reinstalling the device and turning the breakers back on.

The device has no replaceable batteries and no replaceable fuses.

CAUTION: If the equipment is used in a manner not specified by eGauge, the protection provided by the equipment may be impaired.

A EMI Compliance

A.1 FCC Compliance Statement

This equipment has been tested and found to comply with the limits for a Class B digital device, pursuant to part 15 of the FCC Rules. These limits are designed to provide reasonable protection against harmful interference in a residential installation. This equipment generates, uses and can radiate radio frequency energy and, if not installed and used in accordance with the instructions, may cause harmful interference to radio communications. However, there is no guarantee that interference will not occur in a particular installation. If this equipment does cause harmful interference to radio or television reception, which can be determined by turning the equipment off and on, the user is encouraged to try to correct the interference by one or more of the following measures:

- Reorient or relocate the receiving antenna.
- Increase the separation between the equipment and receiver.
- Connect the equipment into an outlet on a circuit different from that to which the receiver is connected.
- Consult the dealer or an experienced radio/TV technician for help.

CAUTION: Changes or modifications to the equipment not expressly approved by eGauge Systems LLC could void the user's authority to operate the equipment.

A.2 Canada ICES-003 Compliance

CAN ICES-3 (B)/NMB-3(B)

B Specifications

B.1 Applicable Model Numbers

This manual applies to all eGauge models ranging from EG4000 through EG4999.

B.2 Electrical Rating of the Product

- AC Mains Connector: 85-277Vrms, 1-3 phases, 50-60 Hz, 12W peak (2W typical).
- DC Connector: 9-60Vdc, 12W peak (2W typical).





B.3 Environmental Conditions

Suitable for indoor and outdoor use (with proper enclosure), Pollution Degree 2, Measurement Category III. Not to be used at altitudes above 4000m. Voltage fluctuations not to exceed $\pm 10\%$. Temperature range: $-30 - 70^{\circ}\text{C}$ ($-22 - 158^{\circ}\text{F}$). Maximum relative humidity 80% up to 31°C , decreasing linearly to 50% at 40°C .

B.4 CE Immunity Statement

Performance criteria: At field-strengths up to 10V/m, no change of state or stored data, may exhibit temporary variation in analogue input values.

B.5 Regulatory Certificates

	UL File Number E495717 IEC/UL 61010-1 Ed. 3.0
	FCC's Title 47 CFR Part 15 Subpart B Class B ICES-003 Information Technology Equipment Class B
	IEC 61000-6-1 Ed. 3.0 B:2016 IEC 61000-6-3 Ed. 2.1 B:2011
	RCM

B.6 Current Transformers (CT)

The EG4xxx is a Listed Device, certified to be used with Listed CTs. The CTs sold by eGauge Systems have been evaluated to ensure correct performance.

The current sensors may not be installed in a panel where they exceed 75% of the wiring space of any cross-sectional area within the panel, in accordance with NEC sections such as 312.8 and 366.9, as well as Articles 300 and 408.

C Troubleshooting and Support Information

Please see the support section of the eGauge website for frequently asked questions, helpful troubleshooting tips, instructional videos, and tutorials at:

<http://kb.egauge.net/>

A quick overview of the installation and setup process can be found at:

<http://egauge.net/start>

C.1 Default Installation Checklist

The eGauge must be configured for what it is monitoring and will not record valid data until done so. Configuration may be done through the main menu and choosing **Setup**→**Other Settings**→**Installation**, or on older meters through **Settings**→**Installation**.

Below is a brief checklist for the above stated installation.

- Read the Owner's Manual.
- Visit egauge.net/start
- Install CTs with stickers facing the measured item.
- Voltage between conductor through CT1 and the L1 terminal reads 0V (If CT1 is on L1).
- Voltage between conductor through CT2 and the L2 terminal reads 0V (If CT2 is on L2).
- Voltage between conductor through CT3 and the L1 terminal reads 0V (If CT3 is on L3)
- Phase check all other CTs and respective lines continuing the above process.
- Black wires on CT leads line up with black circles on CT terminals.
- eGauge Breaker disconnect labelled "eGauge Disconnect".
- If applicable, the HomePlug adapter is connected directly in a wall outlet, within 50-100 feet of the eGauge main unit, and is on the same phase powering L1 of the eGauge.
- eGauge Status is verified through LCD or loading the default webpage.

D Installation Information

Device Location:

Device Name:

Voltage Configuration:

Device Login:

Device Password:

Notes:

CT #	CT Model	Phase	Measured item
1			
2			
3			
4			
5			
6			
7			
8			
9			
10			
11			
12			
13			
14			
15			
16			
17			
18			
19			
20			
21			
22			
23			
24			
25			
26			
27			
28			
29			
30			